



Suorin Air Mod

Please save this manual and read it fully before you start using this product as it contains important information.

User Manual

V2021-04

INSTRUCTIONS FOR USE AND STORAGE OF THE PRODUCT

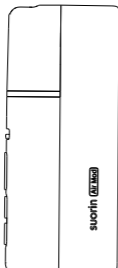

Length	99.6mm
Width	42.6mm
Height	14.1mm
Weight	89.8g

SPECIFICATIONS

Coil Resistance	0.6 Ω
	0.8 Ω
Pod Capacity	2ml
Battery Capacity	1500mAh
Max Output Current	10A
Max Output Wattage	40W
Charging Current	1A
Charging Time	2H
Material	ZincAlloy +Plastic

COMPONENTS

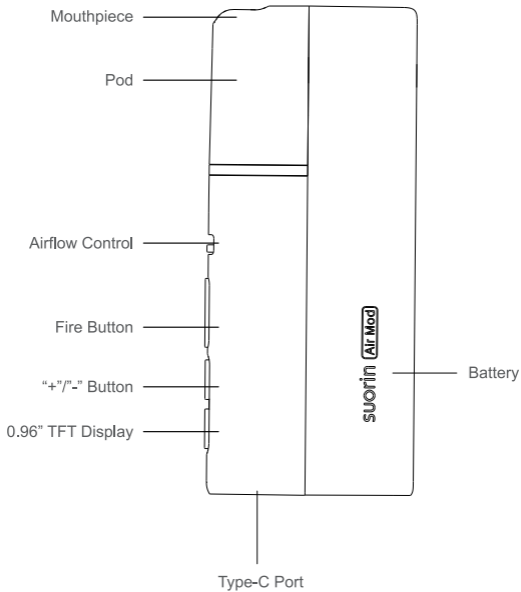

OPERATION GUIDE

How to set up the device

Step 1

Insert the coil into the cartridge

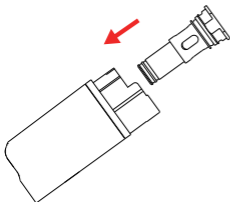

Step 2

Open the silicone plug

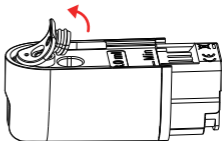

Step 3

Fill the e-liquid in

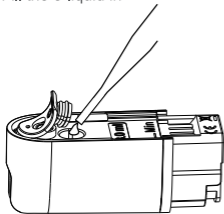

Step 4

Install the cartridge

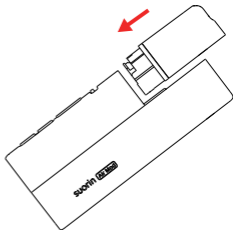

Power On/Off

Press the fire button 5 times continuously in 2 seconds to turn on/off the device. The screen displays the on/off page, and then enters the main screen/off state.

Power Adjustment

In the unlocked state, press the "+" or "-" to increase or decrease the wattage.

Power Locked/Unlocked

Press the "+" and "-" simultaneously to lock or unlock the power. The screen displays "POWER LOCKED" or "POWER UNLOCKED" correspondingly.

Clear Puff Data

In the puff data view state , press fire button and "+" simultaneously. When " Puff Clear Data" appears, press "+"(Yes) to confirm, or press "-"(No) to cancel.

Charging

Plug in the power supply, then the charging status will be shown on the screen.

When the battery voltage is full, the charging will be turned off to prevent the battery from overcharging.



Don't use the product during charging.

LED SCREEN INSTRUCTION

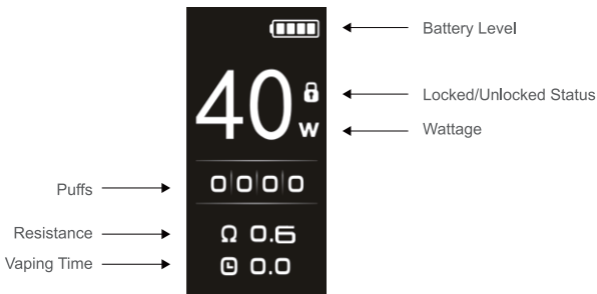

Prompts	Status
Time Over	When vaping time exceeds 8 seconds.
No Atomizer	When no pod is installed or the heating wire is burnt out.
Ohms Too Low	When resistance is too low.
Bat Low	When the battery voltage is low and need charging.

NOTICE



1. Let the cartridge stand up-straight for 5-8 minutes to make sure the cotton is fully saturated.
2. This product is only available for Suorin Air Mod cartridges.
3. Dispose of the contents/container in accordance with local laws.
4. It is not recommended for minors and non-smokers.

TROUBLESHOOTING

1. If the device's battery cannot be charged, check that the charger cord is fully connected to the Type-C port.
2. If aerosol is not emitted normally when puffing on the device:
 - a. Confirm that the cartridge is properly in place and tightly connected to the device.
 - b. Confirm the device is under "on" state.
 - c. Confirm that sufficient e-liquid remains in the cartridge. If not, refill the cartridge.
 - d. Confirm that adequate charge remains in the battery. If not, please charge as soon as possible. If the product still does not work, email our customer service center at info@suorin.com for further assistance.

CONTRA-INDICATIONS:

When the product is used with e-liquids, it's not recommended for

- Pregnant women, those who suspect they may be pregnant or plans to become pregnant in the near-term or are breastfeeding
- People who are assuming nicotine through other devices or safeguards designed to detox from nicotine as plasters, pills, chewing gum
- People in interdiction condition or disabled and mentally incapacitated temporarily or permanently

WARNINGS FOR SPECIFIC RISK GROUPS

When the product is used with e-liquids, call your doctor before using this product if:

- You have any medical condition which includes, but is not limited to, heart failure or other heart diseases, diabetes, high blood pressure, asthma, kidney or liver disease, psychiatric disorders
- You suffer from gastritis, gastric ulcer, duodenal ulcer, gastro-esophageal reflux disease
- You are allergic to one or more label ingredients
- You are using any medication that may interact with nicotine
- You suffer from pre-existing disease that in the advice of your doctor may be a contraindication
- You have any doubt on the use of the product

POSSIBLE ADVERSE EFFECTS

When the product is used with e-liquids: After skin/eye contact rinse with plenty of water and contact your doctor if irritation reactions will appear.

Possible effects of the nicotine consumption are: Coughing, headache, irritation of the Mouth and throat, nasal congestion, aphthous ulcers, sore throat, anxiety, insomnia, depression, discomfort, nausea, dry mouth, heartburn, aching joints, diarrhea, meteorism, allergy (skin eruption, shortness of breath, laboured breath, tightness of the chest, swelling of the face, tongue and lips), feeling thirsty, hiccups, chest pain, fever, irregular or increased heart beat, dizziness, sleepiness. Possible adverse effects associated with overdose: Nausea, salivation, abdominal pain, diarrhea, sweating, headache, dizziness, hearing problems, weakness, palpitation.

ADDICTIVENESS AND TOXICITY

When the product is used with e-liquids containing nicotine:

Nicotine is a highly toxic addictive substance.

Shenzhen Youme Information Technology Co.,Ltd.

E-mail:info@suorin.com

Web:www.suorin.com

Instagram:@Suorinofficial

Add:201, Building B, Dianlian technology building, Nanhuan Avenue,
Mashantou Community, Matian street, Guangming District, Shenzhen





CAUTION

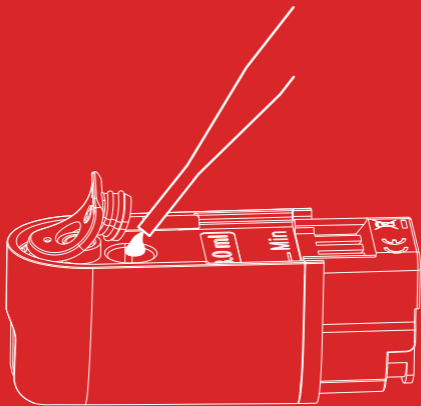

- Please let the cartridge stand for 5-8 minutes after filling e-liquid. Make sure the cotton is fully saturated.
- It is recommended to change a new coil after filling e-liquid for 5-8 times or within 7 days after e-liquid filling.